

Features

- * Integral current limiting resistor LED.
- * Chip resistor built in, required with 12 volts supply.
- * Cost effective (save external resistor space and cost)

Package Dimensions

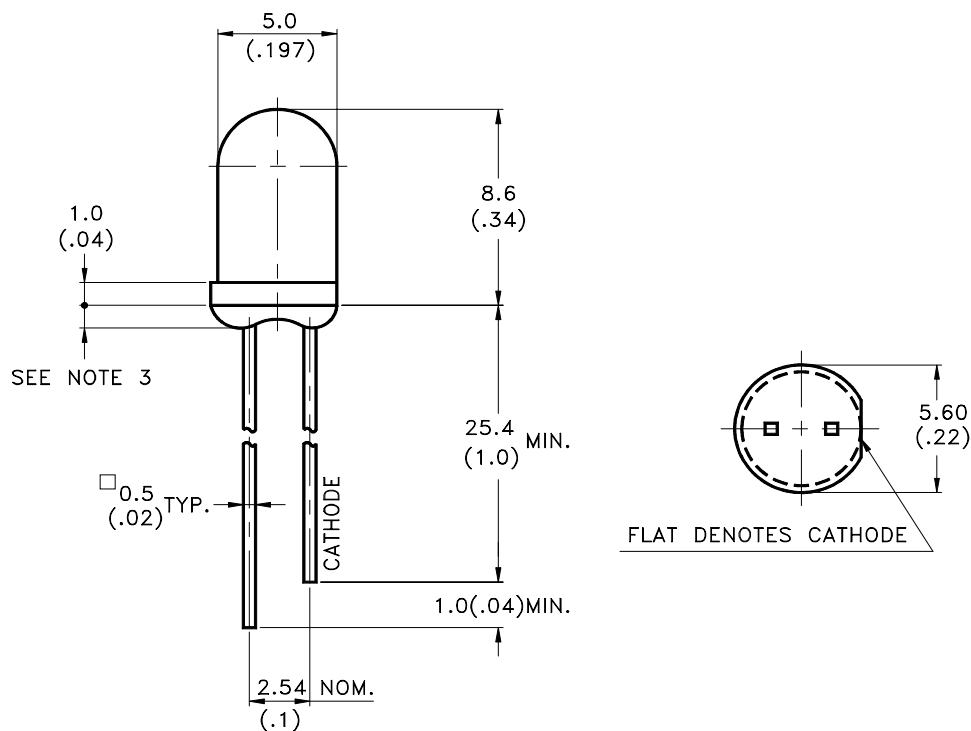

Part No.	Lens	Source Color
LTL-4223-R2	Red Diffused	Hi-Eff.Red

Notes:

1. All dimensions are in millimeters (inches).
2. Tolerance is $\pm 0.25\text{mm}(.010\text{'})$ unless otherwise noted.
3. Protruded resin under flange is 1.0mm(.04") max.
4. Lead spacing is measured where the leads emerge from the package.
5. Specifications are subject to change without notice.

Absolute Maximum Ratings at TA=25°C

Parameter	Maximum Rating	Unit
DC Forward Voltage (TA=25°C)	15	V
Derating Linear From 50°C	0.086	V/°C
Reverse Voltage	5	V
Operating Temperature Range	-40°C to +85°C	
Storage Temperature Range	-55°C to +100°C	
Lead Soldering Temperature [1.6mm(.063") From Body]	260°C for 5 Seconds	

Equivalent circuit:

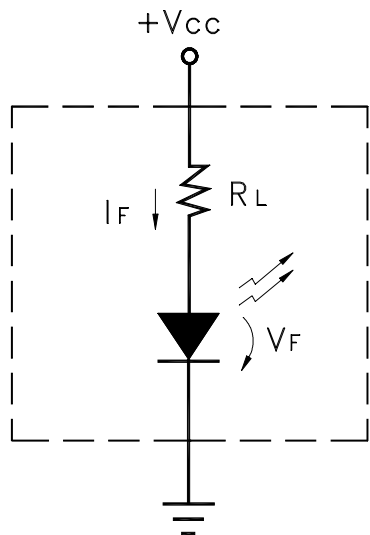

Vcc = 12 Volts
(RL = 800 ohms±20%)

$$I_F = \frac{V_{CC} - V_F}{R_L}$$

Electrical / Optical Characteristics at TA=25°C

Parameter	Symbol	Min.	Typ.	Max.	Unit	Test Condition
Luminous Intensity	I _v	8.7	29		mcd	V _{CC} = 12V Note 1,4
Viewing Angle	2θ _{1/2}		36		deg	Note 2 (Fig.5)
Peak Emission Wavelength	λ _P		635		nm	Measurement @Peak (Fig.1)
Dominant Wavelength	λ _d		623		nm	Note 3
Spectral Line Half-Width	Δλ		40		nm	
Forward Current	I _F	8	12	16	mA	V _{CC} = 12V
Reverse Current	I _R			100	μA	V _R = 5V

- Note: 1. Luminous intensity is measured with a light sensor and filter combination that approximates the CIE (Commission International De L'Eclairage) eye-response curve.
2. θ_{1/2} is the off-axis angle at which the luminous intensity is half the axial luminous intensity.
3. The dominant wavelength, λ_d is derived from the CIE chromaticity diagram and represents the single wavelength which defines the color of the device.
4. The I_v guarantee should be added ± 15% .

Typical Electrical / Optical Characteristics Curves

(25°C Ambient Temperature Unless Otherwise Noted)

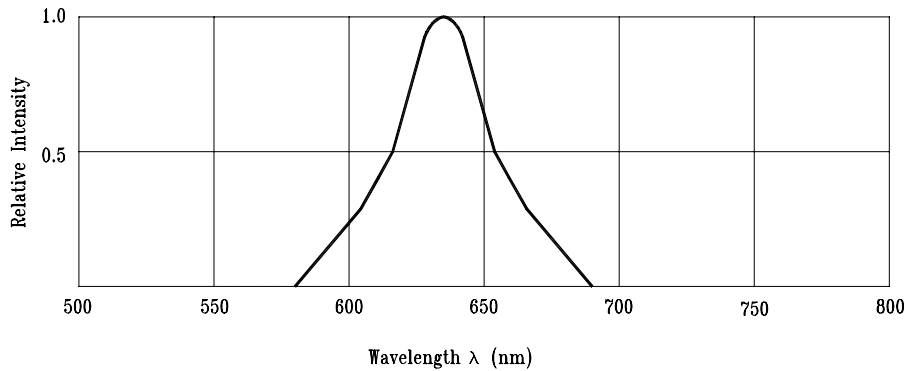
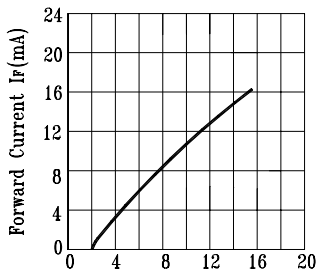
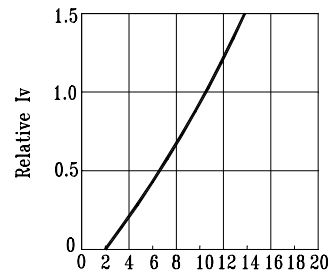

Fig.1 Relative Intensity vs. Wavelength



Applied Forward Voltage V_{cc} (V)

Fig.2 Forward Current vs. Applied Forward Voltage
12 Volts Devices



Forward Current (mA)

Fig.3 Relative Luminous Intensity vs. Applied Forward Voltage
12 Volts Devices

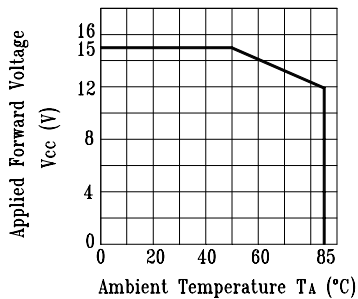

Fig.4. Maximum Allowed Applied Forward Voltage vs. Ambient Temperature
12 Volts Devices

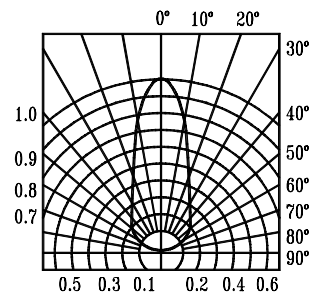

Fig.5 Spatial Distribution